



figure **287**
ends form flanged straight



ΒΑΛΒΙΔΕΣ ΑΝΤΕΠΙΣΤΡΟΦΗΣ PN40



CHECK VALVE

body material	nominal pressure	nominal diameter	max. temperature
A grey cast iron	C 16 bar	DN 15-300	300°C
C nodular cast iron	C 16 bar	DN 15-200	350°C
	D 25 bar	DN 15-200	350°C
F cast steel	E 40 bar	DN 15-200	400°C
E bronze	A 6 bar	DN 250-300	225°C
	B 10 bar	DN 150-200	225°C
	C 16 bar	DN 15-125	225°C



correspond to the pressure equipment directive 97/23/EC marking CE for DN≥32

FEATURES

- closing tightness acc. EN -12334
- compact settlement
- environment-friendly
- no maintenance
- face-to-face dimension according to EN 558-1 series 1
- flanges drilled according to EN 1092-1 for type F
- flanges drilled according to EN 1092-2 for type A,C,E

APPLICATION

- hot and cold water plants
- steam plants
- industrial technologies
- neutral fluids
- heat and refrigerating engineering,

Data given can be changed without notice.

Edition 10/2012

ZETKAMA Spółka Akcyjna
ul. 3 Maja 12
PL 57-410 Ścinawka Średnia

tel. +48 74 8652 174
tel. +48 74 8652 100
fax +48 74 8652 199

e-mail marketing@zetskama.com.pl
www.zetskama.com.pl



figure **287**
ends form flanged
form straight



MATERIALS

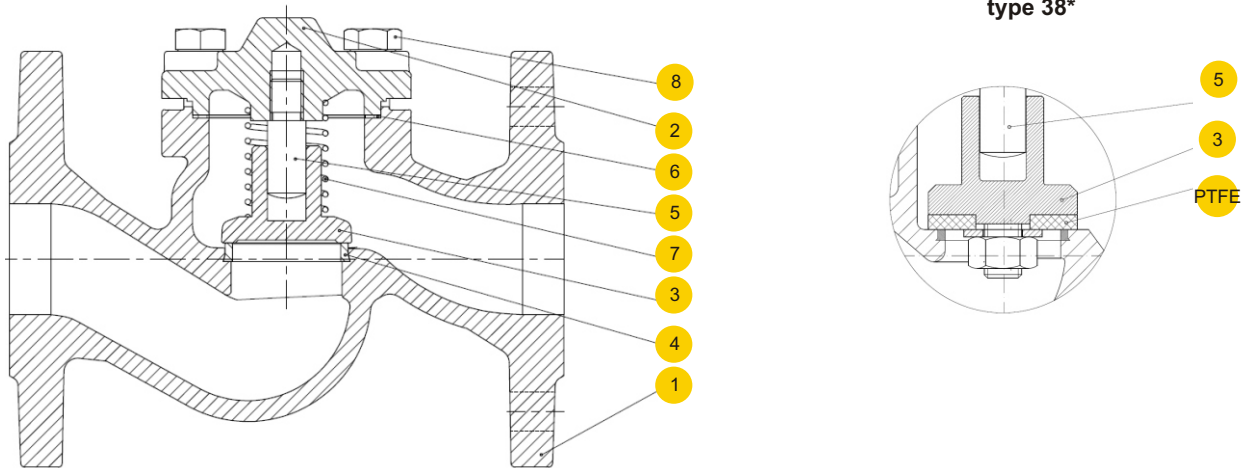

	body material	A	C	F	A	C	E
	type	31; 41			33,43		32
1	body	EN – GJL-250 5.1301(ex.JL1040)	EN – GJL-400-18 5.3103(ex.JS 1025)	GP240GH 1.0619	EN – GJL-250 5.1301(ex.JL1040)	EN – GJL-400-18 5.3103(ex.JS 1025)	CuSn5Zn5Pb5-C
2	cover	EN – GJL-250 5.1301(ex.JL1040)	EN – GJL-400-18 5.3103(ex.JS 1025)	GP240GH 1.0619	EN – GJL-250 5.1301(ex.JL1040)	EN – GJL-400-18 5.3103(ex.JS 1025)	CuSn5Zn5Pb5-C
3	disc		X20Cr13 1.4021		CuSn10		DN15-32 CuZn35Ni DN40-300 CuSn5Zn5Pb5-C
4	seat ring		X12Cr13 1.4006		CuSn10		CuSn5Zn5Pb5-C
5	stem		X20Cr13 1.4021		CuSn10		DN15-32 CuZn35Ni DN40-300 CuSn5Zn5Pb5-C
6	gasket	graphite CrNi					FA1
7	spring		X17CrNi16-2 1.4057		CuSn6		-
8	hexagon bolt	8.8 A2A					
	max. temperature	300°C	350°C	400°C	225°C		

* on request max. temperature 200°C

Data given can be changed without notice.

Edition 10/2012

ZETKAMA Spółka Akcyjna
ul. 3 Maja 12
PL 57-410 Ścinawka Średnia

tel. +48 74 8652 174
tel. +48 74 8652 100
fax +48 74 8652 199

e-mail marketing@zetskama.com.pl
www.zetskama.com.pl

2/6

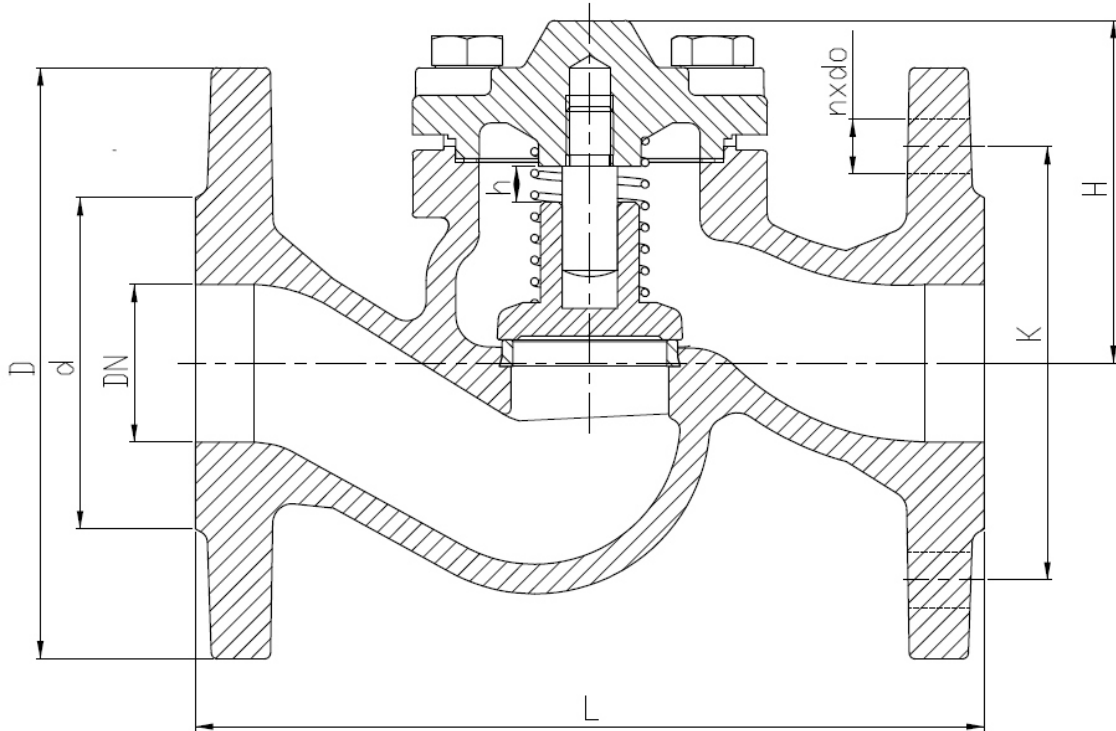

figure **287**
ends form flanged straight



ZETKAMA

DIMENSIONS



DN	PN 16 PN 25 PN 40	PN 16				PN 25				PN 40				PN 16 PN 25		PN 40		A, C	F	E
	L	D	d	K	nxdo	D	d	K	nxdo	D	d	K	nxdo	h	H	h	H			
mm																		kg		
15	130	95	46	65	4x14	95	46	65	4x14	95	45	65	4x14	5	56	6	75	2,1	3,5	3,5
20	150	105	56	75	4x14	105	56	75	4x14	105	58	75	4x14	5	56	6	75	2,7	4,5	4,0
25	160	115	65	85	4x14	115	65	85	4x14	115	68	85	4x14	8	67	6	75	3,8	5,5	5,0
32	180	140	76	100	4x19	140	76	100	4x19	140	78	100	4x18	8	76	10	91	5,5	8,0	6,0
40	200	150	84	110	4x19	150	84	110	4x19	150	88	110	4x18	11	89	10	91	7,4	11,0	8,5
50	230	165	99	125	4x19	165	99	125	4x19	165	102	125	4x18	14	96	16,5	124	9,5	14,0	11,0
65	290	185	118	145	4x19	185	118	145	8x19	185	122	145	8x18	17	104	16,5	125	15,0	23,0	15,0
80	310	200	132	160	8x19	200	132	160	8x19	200	138	160	8x18	21	124	25	175	20,0	30,0	20,0
100	350	220	156	180	8x19	235	156	190	8x23	235	162	190	8x22	25	161	25	176	29,0	47,0	25,0
125	400	250	184	210	8x19	270	184	220	8x28	270	188	220	8x26	32	174	40	260	41,0	70,0	40,0
150	480	285	211	240	8x23	300	211	250	8x28	300	218	250	8x26	38	197	40	260	66,0	96,0	55,0
200	600	340	266	295	12x23	360	274	310	12x28	375	285	320	12x30	50	248	50	270	111	100	95
250	730	405	319	355	12x28	-	-	-	-	-	-	-	-	65	295	-	-	196	-	140
300	850	460	370	410	12x28	-	-	-	-	-	-	-	-	95	315	-	-	302	-	250

Data given can be changed without notice.

Edition 10/2012

ZETKAMA Spółka Akcyjna
ul. 3 Maja 12
PL 57-410 Ścinawka Średnia

tel. +48 74 8652 174
tel. +48 74 8652 100
fax +48 74 8652 199

e-mail marketing@zetkama.com.pl
www.zetkama.com.pl

3/6



figure **287**
ends flanged
form straight



PRESSURE-TEMPERATURE RATINGS

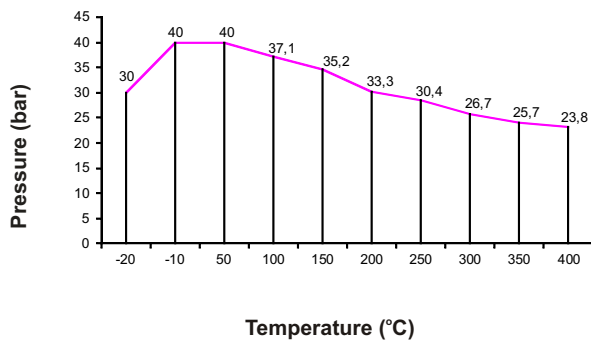
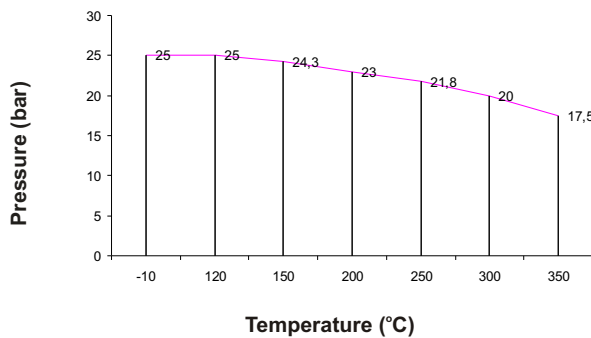
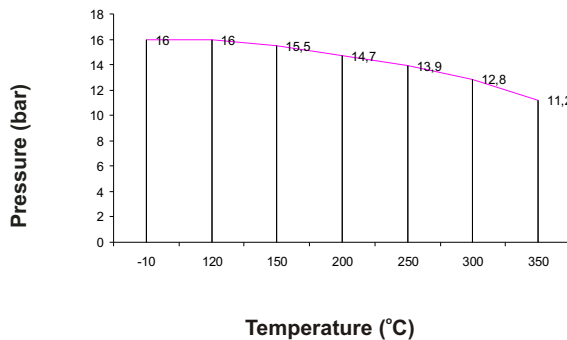
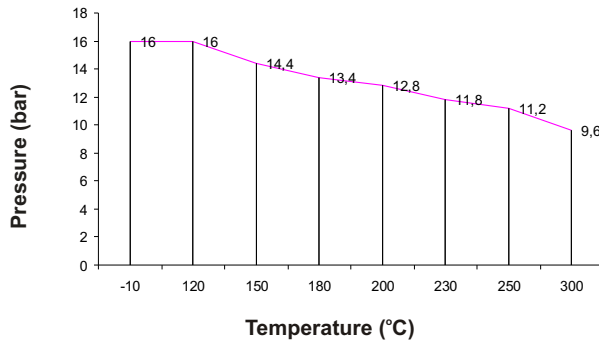

Data given can be changed without notice.

Edition 10/2012



figure **287**
ends form flanged straight



TYPES

figure	body material	nominal diameter DN	nominal pressure PN	type
287	A grey cast iron EN-GJL-250	15-300 mm	C 16bar	31 * loose disc with spring * stem, disc and seat ring - stainless steel Tmax 300 °C
				38 * loose disc with spring * stem, disc and seat ring - stainless steel * disc gasket PTFE Tmax 120 °C
				41 * loose disc without spring * stem, disc and seat ring - stainless steel Tmax 300 °C
				33 * loose disc with spring * stem, disc and seat ring - bronze Tmax 225 °C
				43 * loose disc without spring * stem, disc and seat ring - bronze Tmax 225 °C
	C nodular cast iron EN-GJS-400-18-LT	15-200 mm	C 16bar	31 * loose disc with spring * stem, disc and seat ring - stainless steel Tmax 350 °C
				38 * loose disc with spring * stem, disc and seat ring - stainless steel * disc gasket PTFE Tmax 120 °C
				41 * loose disc without spring * stem, disc and seat ring - stainless steel Tmax 350 °C
				33 * loose disc with spring * stem, disc and seat ring - bronze Tmax 225 °C
				43 * loose disc without spring * stem, disc and seat ring - bronze Tmax 225 °C
D 25bar			31 * loose disc with spring * stem, disc and seat ring - stainless steel Tmax 350 °C	
			38 * loose disc with spring * stem, disc and seat ring - stainless steel * disc gasket PTFE Tmax 120 °C	
			41 * loose disc without spring * stem, disc and seat ring - stainless steel Tmax 350 °C	
			33 * loose disc with spring * stem, disc and seat ring - bronze Tmax 225 °C	
			43 * loose disc without spring * stem, disc and seat ring - bronze Tmax 225 °C	

Data given can be changed without notice.

Edition 10/2012

ZETKAMA Spółka Akcyjna
ul. 3 Maja 12
PL 57-410 Ścinawka Średnia

tel. +48 74 8652 174
tel. +48 74 8652 100
fax +48 74 8652 199

e-mail marketing@zetkama.com.pl
www.zetkama.com.pl

5/6



figure **287**
ends form flanged straight



TYPES

figure	body material	nominal diameter DN	nominal pressure PN	type
287	F cast steel GP240GH 1.0619	15-200 mm	E 40bar	31 * loose disc with spring * stem, disc and seat ring - stainless steel Tmax 400 °C
	E bronze CuSn5Zn5Pb5-C	15-125 mm	C 16bar	32 * loose disc with spring * stem- brass, disc and seat ring - bronze Tmax 225 °C
		150-200 mm	B 10bar	32 * loose disc with spring * stem- brass, disc and seat ring - bronze Tmax 225 °C
		250-300 mm	A 6bar	32 * loose disc with spring * stem- brass, disc and seat ring - bronze Tmax 225 °C

ORDERING

To place an order please use our product number (index)

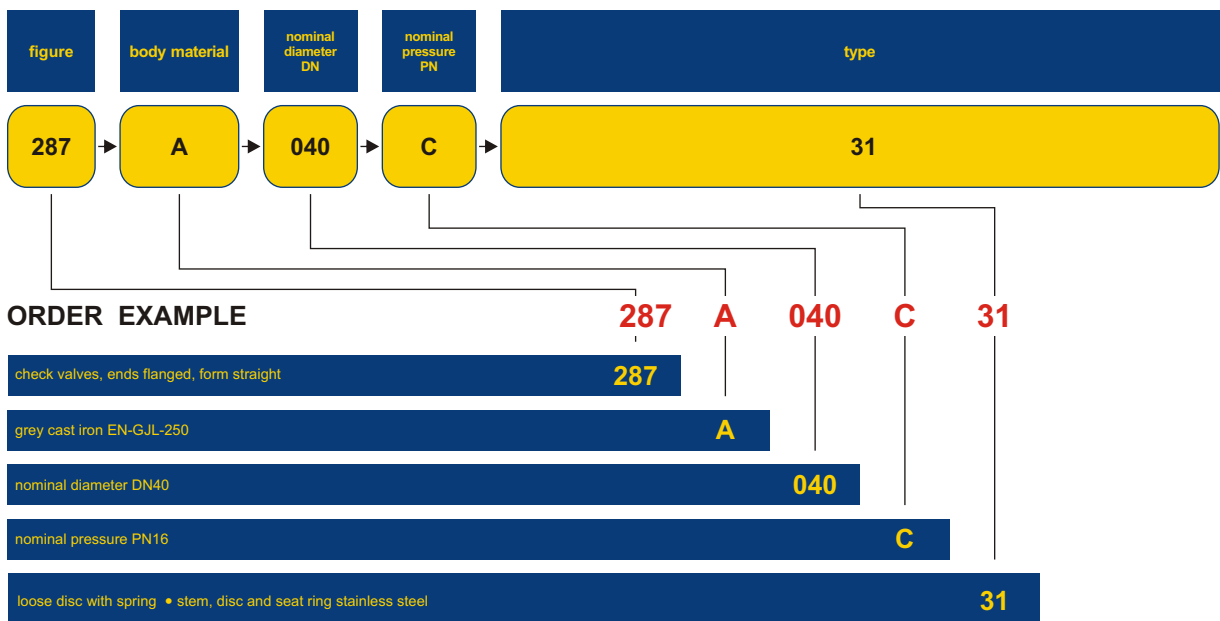

Data given can be changed without notice.

Edition 10/2012