

The evolution of the ...



SESTA SRL

technical catalogue 1/2010



...SESTA system tubing

index

SESTA SRL	2
Reference regulations	3
Passage from the uni 10954 regulations to the uni en iso 21003	3
Potability	5
The SESTA GAS system	6
Combustible gas transport systems uni/ts 11344	6
The SESTA system	7
The multilayer tube	7
The advantages of aluminium	8
The advantages of pe-xb	9
Reticulated polyethylene	10
Sesta fittings	13
Press profiles	14
Technical specificatione	16
The tubes	16
The fittings:	19
Insulated tubes	21
Quality control	23
Raw materials inspections	23
Automatic on line checks and inspections	24
Final on line checks and inspections	24
Laboratory control	25
Fittings inspections	26
System checks and verifications	26
Additional tests for systems for combustible gas transport	27
The certificates	28
Installation information	31
Fitting installation instructions	33
Bending	35
Thermal dilation	35
Load loss	36
Guaranties, responsibilities, insurance	38

Sesta srl, arose from over 40 years of experience in industrial and civil plumbing and heating.

The **Sesta System**, made up of multilayer tubes and brass press fittings, has been conceived for the realisation of hot and cold potable water distribution systems as well as for high and low temperature climate control, heating and cooling systems.

The creation of the system was characterised by the utilisation of the most evolved and advanced production technology and materials both for the tube and for the press fittings.

For the tubes:



- The finest type b (PE-Xb) reticulated polyethylene plastic material made to withstand high temperatures both indoors and outdoors;
- 8006 aluminium alloy, stronger than other alloys, suitable for the reduced thicknesses that enable great flexibility;
- TIG butt-to-butt method aluminium welding, giving the greatest reliability for bends, thanks to the characteristics of strength and uniformity.

For the fittings:

- Anti-dezincification brass, resistant to corrosion also in presence of particularly aggressive water;
- The stainless steel bushing enables a more reliable press fitting than with other metals in use;
- Peroxide vulcanised EPDM O-ring, potable water grade, or compliant with UNI EN 682 for gas.

The quality of the *multilayer tubes*, the *fittings* and of the total *Sesta System* has been certified BY two of the most prestigious European institutes: the DVGW and the Italian Institute of Plastics (IIP).

reference regulations

The sesta system complies WITH the UNI EN ISO 21003 :
 21003-1 Generalities
 21003-2 Tubing
 21003-3 Fittings
 21003-5 Suitability for use of the system
 21003-7 Guide for the compliance evaluation



Passage from the UNI 10954 Regulations to the UNI EN ISO 21003



The UNI 10954 Regulations has identified three classes establishing three regression lines at the temperature of 95 °C.

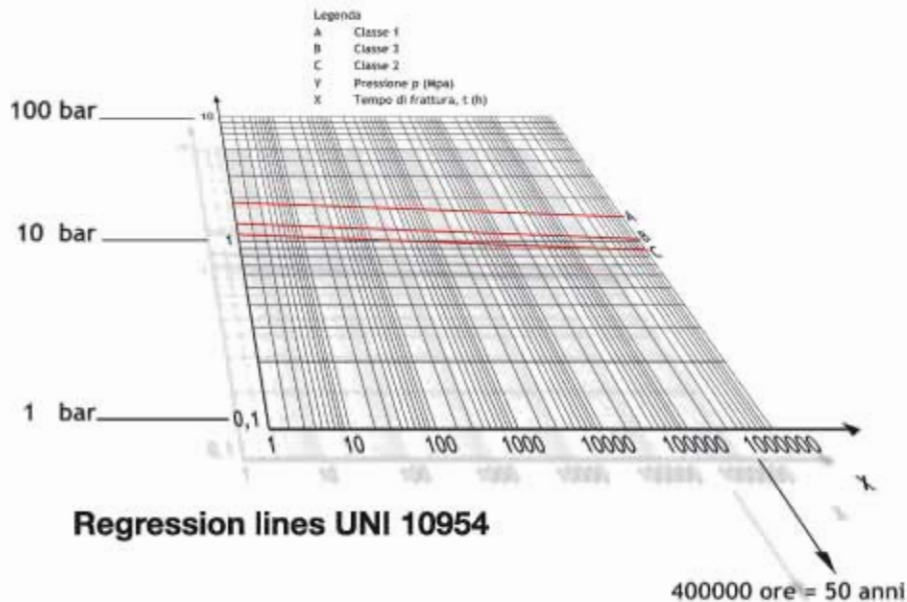

These indicated the pressure that the system was to withstand over time, up to 50 years. The manufacturer in order to establish its own class had simply to have its system undergo a test temperature of 95 °C for the duration and the pressures in the table below:

Duration (h)	Test Pressure (bar)		
	Class 1	Class 2	Class 3
>165	20,2	11,6	14,2
>1000	19,7	11,3	13,9

Tab. 1

The Sesta System was always tested in compliance with the Class 1 parameters.

Since the 2009 introduction of the **UNI-en-ISO 21003** changed the rationale: this requires the different manufacturers to elaborate their own regression curves through certified laboratories and to therefore define their own time, temperature and pressure parameters which their product must resist.

From the results obtained the classification of the system according to the 4 classes established has been derived:

class	Project T °C	Time a Project YEARS	Maximum Project T°C	Maximum Time YEAR	Malfunction T°C	Time at T mal. h	field of application
5	20-60-80 più	14-25-10	90	1	100	100	High temperature radiators
4	20-40-60 più	2,5-20-25	70	2,5	100	100	Under floor heating and low temperature radiators
2	70	49	80	1	95	100	Potable hot water 70°C
1	60	49	80	1	95	100	Potable hot water 60°C

Tab. 2

The UNI EN ISO 21003 Regulations therefore have different and additional requirements compared to the UNI 10954 Regulations, such as the long-term pressure resistance test and its validation, thermal durability (8760h at 110°C), the bending test and the shear strength test as well.

Tab. 3

Long term pressure Resistance (measured or calculated)	ISO 17456 ISO 1167 a) evaluation - ISO 17456 b) validation 8760 h (1 year)
Thermal durability (*)	Appendix C + D UNI EN ISO 21003 a) internal layer 8760 h (1 year) b) external layer: bending and shear
Weld line resistance	ISO 17456 ISO 1167 The test is considered satisfied if it exceeds the thermal durability test (*)

From the outcome of the tests the Sesta System is suitable for all of the classes of the UNI EN ISO 21003 Regulations.



Potability

The Sesta System is suitable for potable water supply in compliance with the binding regulations on Global Migration and specifics indicated in the M.D. 174/2004 beyond KTW 20°C and 60°C – W270 reference DVGW.

DIVISIONE: DIVISION:	FOOD PACKAGING MATERIALS
LABORATORIO: LABORATORY:	FOOD
RAPPORTO DI PROVA (Test Report)	
D.M. 174 (ACQUA POTABILE) MIGRAZIONE GLOBALE IN ACQUA MIGRAZIONE SPECIFICA COMPOSTI NON DICHIARABILI N° 0022/FPM/FDC/10	
IDENTIFICAZIONE E DESCRIZIONE DEL CAMPIONE: SPECIMEN DESCRIPTION: Tube DN 20, prodotto con POLIDAN T/A + 5% CATALYS	
DATI IDENTIFICATIVI DEL CLIENTE: CLIENT: SESTA s.r.l. Via V. Lancia - Contrada Olivola Z.I. 82100 BENEVENTO (BN)	
NORMA DI RIFERIMENTO: REFERENCE STANDARD: DM del 21.3.73 S.O. GU n° 154 del 30/04/73 e successivi aggiornamenti e modifiche tra cui il DM 220 del 13/07/83 e l'Allegato del Decreto 338 del 22/07/98 GU n° 228 del 30/09/98, DM 174/2004, Dv. 82/711/CE, 85/720/CE, GUCE L 372 del 31/12/1985, Dv. 87/48/CE, GUCE L 222 del 12/01/87, Dv. 3002/72/CE, GUCE L 315/80 del 17/11 del 10/10/84, Dv. 2003/74/CE, GUCE L 302 del 18/11/05, Dv. 2007/19/CE, GUCE L 81 del 31/01/08, Dv. 07/03/2008, Reg. CE 1935/2004, e Reg. CE 97/52/CE, GUCE L 338 del 13/11/04, UNI-EN 1106 1-15 2003	
DISTRIBUZIONE ESTERNA: OUTSIDE DISTRIBUTION: SESTA s.r.l. Sig. Luca Corsale	DISTRIBUZIONE INTERNA: INSIDE DISTRIBUTION: Copia: Responsabile Di...
ENTE DI ACCREDITAMENTO: ACCREDITATION BODY:	
GRUPPO IMQ	
CSI S.p.A. Sede Legale - 10010 - Latissona Via Lancia, 35 - 00211 BENEVENTO (BN) Tel. 0225261 - Fax 0225266 www.csispa.com	S.E.A. 198039 Registro Imprese 02164950314 C.F.P.A. 71126450421 Cap. Soc. € 1.945.000

Hygiene-Institut des Ruhrgebiets			
Institut für UmweltHygiene und Umweltmedizin Direktor: Prof. Dr. rer. nat. L. Dörmann			
Postfach: Postfach 11 110 - 48127 Gelsenkirchen - 0204401			
SESTA SRL Via Lancia, snc c/o Contrada Olivola, Z.I. 82100 BENEVENTO ITALIEN		Postfach Nr. 19 45870 Gubenkirchen Telefon: +49 (0)89 0042 2 Telefax: +49 (0)89 0042 251 Telefax: +49 (0)89 0042 212 E-Mail: s.dormann@hyg.de Internet: www.hyg.de Referenz: C 16669-08-Gutst Contact person: Mr. Reinhold Engl Datum/Date: 19.08.2008	
TEST CERTIFICATE according to the KTW-Guideline of Federal Environment Agency (UBA)			
Product:	multilayer pipe PoXb/AlPoXb DN16-DN20 (white)		
Test specimen:	multilayer pipe PoXb/AlPoXb DN16 ID = 12 mm		
Kind of test:	<input checked="" type="checkbox"/> Product test / Permission test <input type="checkbox"/> Supervision test		
The s.r.l. multilayer pipe PoXb/AlPoXb DN16-DN20 (white) meets the requirements according to the test report dated 19.08.2008, Ref.No.: C-16669-08-Gutst for the following applications and temperatures:			
Applications:	cold water (10°C)	moderately hot water (60°C)	extremely hot water (95°C)
Pipes ID < 80 mm (domestic distribution)	passed	passed	—
Pipes 80 mm ≤ ID < 300 mm (supply pipelines)	passed	passed	—
Pipes ID ≥ 300 mm (trunk)	passed	passed	—
Simple fittings, assembled product housings for pipes ID < 80 mm	passed	passed	—
Simple fittings, assembled product housings for pipes 80 mm ≤ ID < 300 mm	passed	passed	—
Simple fittings, assembled product housings for pipes ID ≥ 300 mm	passed	passed	—
Seals for pipes ID < 80 mm	passed	passed	—
Seals for pipes 80 mm ≤ ID < 300 mm	passed	passed	—
Seals for pipes ID ≥ 300 mm	passed	passed	—
Storage systems within the domestic distribution system including repair products	passed	passed	—
Storage systems outside the domestic distribution system including repair products	passed	passed	—
as far as technically suited.			
This test certificate is valid beginning with the date of issue and is ending by 19.08.2013 as far as there are no changes in the formula. After this time it can be extended for further 5 years if demanded.			
The Director of the Institute on behalf of: (Dr. rer. nat. A. Koch)			
The results and conclusions mentioned refer to the investigated samples and the relevant laws. The validity of this document expires in case of modifications in the composition of the product or the processing conditions. This document shall not be reproduced except in full, without our written approval.			
Bsp: für Hygiene-Institute: Permit zur Befähigung für Tätigkeiten im Lebensmittelbereich e.V., Seelheim			



the sesta gas system uni/ts 11344

**CHRYSSAFIDIS****Innovation year 2010**

Combustible Gas Transport Systems UNI/TS 11344

In December of 2009 the **UNI/TS 11344** Regulations came into effect: metal-plastic tube systems and fittings suitable for the realisation of internal plant systems for the transport of combustible gasses supplied by the gas mains distribution network with a maximum service pressure of 0.5 bar and service temperature of -20°C a $+70^{\circ}\text{C}$. The Sesta system is intrinsically suitable for the supply and transport of combustible gasses. The Sesta System underwent the following additional tests indicated by the UNI TS 11344 Regulations:

- Gas constituents resistance test, according to the UNI EN ISO 1167-1-2 (appendix C) Regulations
- Service temperature resistance test: maximum service pressure of 0.5 bar and service temperature of -20°C a $+70^{\circ}\text{C}$.
- Fire reaction test UNI EN 13501
- O-ring UNI EN 682

which together with those indicated by the UNI EN ISO 21003 regulations make the Sesta System suitable for the supply of combustible gasses (UNI TS 11343), only if there is compliance with the criteria for design, installation and maintenance indicated by the **UNI / TS 11343** Regulations.



the sesta system

sanitary - heating - conditioning

uni en iso 21003



SESTA IIP 348/UNI 21003



Multilayer Tubing

Multilayer SESTA tubing is made up of 5 layers.

- PE-Xb Reticulated Polyethylene
- Adhesive resin
- TIG method butt-to-butt welded aluminium
- Adhesive resin
- PE-Xb Reticulated Polyethylene

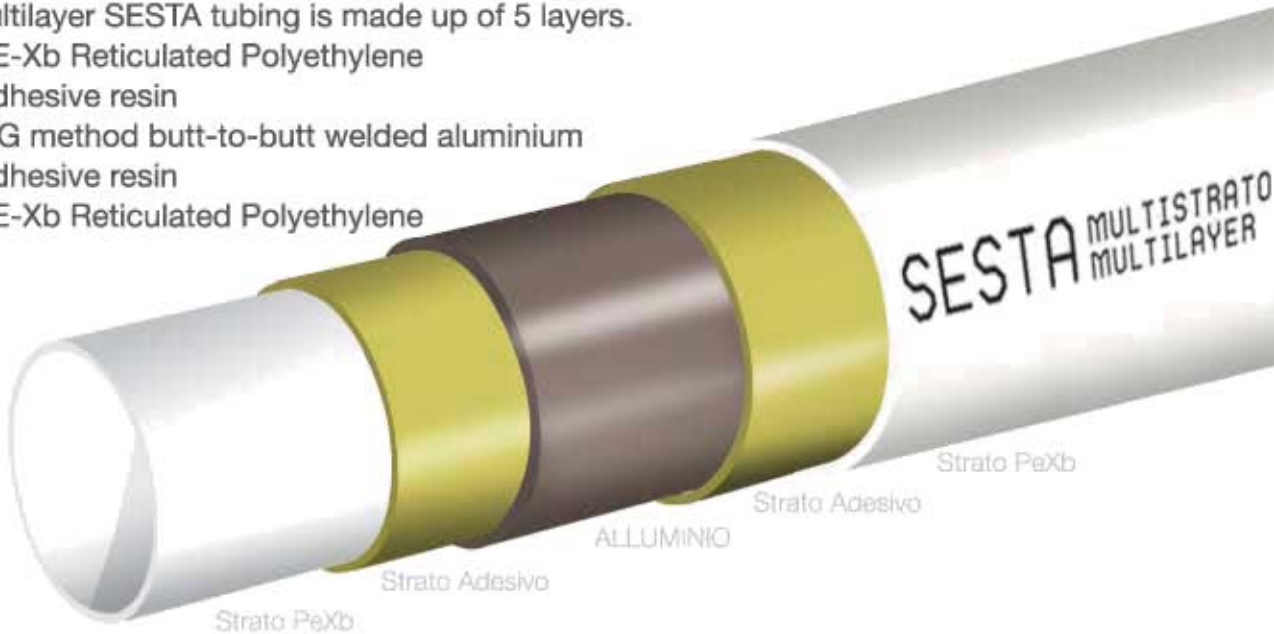

The limits of the single materials are exceeded by the combination: The negative aspects of metal, such as corrosion, rigidity, fouling and high load loss are neutralised by the Reticulated Polyethylene layer in contact with the fluid. The negative aspects of plastic such as gas and UV ray permeability, elevated thermal dilation and instability are neutralised by the layer of aluminium between the two layers of Pe-Xb.

Sesta, for its tubing, has chosen the most advanced process and product technology.

The firm has set up a production line with components supplied by the most prestigious companies found on the market and with totally advanced instrumentation systems enabling the narrowest tolerances for the thicknesses of each of the layers to be had.



Internal and external PE-Xb and butt welded aluminium tube have been indicated for the product.

This technology different from others such as the welding of the aluminium with overlapping edges, given the intrinsic uniformity of the tube, offers the maximum reliability against shear hazard during bending operations. Perfect control over the thicknesses and diameters of the different layers and the use of adhesive resins enable a perfect attachment among the layers to be achieved, making the tube homogeneously resistant.

Comparative table in mm for stretching of 5 metre pipe with Δt 50°C

Tab. 4

PE-X	50
PP	45
PB	37,5
PVC	20
MULTISTRATO	6,50
RAME	4,12
FERRO ZINCATO	2,85
ACCIAIO	2,75

The advantages of Aluminium



Workability

Thanks to the aluminium core, the multilayer tube does not have "memory effect" as all plastic tubes do: once bent and formed, it maintains the form taken.

Dimensional stability

The resistance that distinguishes aluminium makes crushing due to external loads more difficult.

Flexible, crush proof and stable

Multilayer tubing is easily bent, like plastic tube, but it remains stable in the position desired, as metal tubing does. It is possible to work this tubing several times without its being damaged. The bending radius may be varied up to a minimum of five times the diameter of the tube, using a tube bender, and its section is not reduced, but remains constant.

Low linear dilation

The table below shows that the thermal dilation of the multilayer is near to that of metals and much lower than that of plastics

Oxygen barrier

The aluminium protects the plastic inside of the tube forming an absolute barrier against oxygen and light.

Bending

By hand: 5 times the external diameter of the tube.

With a tube bender: 3.5 times the external diameter of the tube.



Tab. 5

	14x2	16x2	18x2	20x2	26x3	32x3
<i>with hand</i>	5xDE	5xDE	5xDE	5xDE	(5xDE)	(5xDE)
<i>utensil</i>	3,5xDE	3,5xDE	3,5xDE	3,5xDE	3,5xDE	3,5xDE

Comparative table

Tab. 6

Peculiarity	Multy-Layer SESTA	COPPER	PLASTIC
oxygen absorption	NO	NO	YES
thermic conductivity	0,43 W/m°K	380 W/m°K	0,38 W/m°K
dilation coefficient	0,026	0,024	0,13/0,25 minimo/m°c
corrosion towander currents	NO	YES	NO
cold workable	YES	YES	NO
mechanical degradation	NO	INCRUDISCE	SHOCK
ageing uva beams	NO	NO	YES



The advantages of PE-Xb

Resistance to corrosion

The external tube in PE-Xb stops the corrosion of the metal part of the tube by construction materials (lime, cement).

Load loss

The internal part of the tube in PE-Xb, free of roughness, keeps loss of load to a minimum also impeding the formation of obstructions caused by lime scale.

Potability

The reticulated Polyethylene that makes up the internal part of the tube has the hygienic requirements necessary for it to be used of the transport of potable water and food liquids.

Resistance to high temperatures

The PE-Xb utilised on the inside and the outside is by its nature resistant to high temperatures, and it enables the use of the multilayer tube both in under-floor heating systems as well as in traditional radiators

Lightweight

The light weight of the plastic makes the tube extremely easy to handle in transport, storage and during installation. A 100-metre roll of the DN 16x2 weighs a mere 11 kg.

Noise levels

The two layers of plastic attenuate the noise caused by the fluid flowing in the tube also in the presence of water hammering.

Reticolate type

The polyethylene (PE) used to manufacture SESTA Multi-layer tubing is cross-linked(X) using the "b" PEXb method

The cross-linking of the polyethylene consists of the break down of carbon-hydrogen bonds at one or more points in the majority of the points of the polymer chains and then the formation of new transversal bonds between the chains: this be done via three methodologies defined as "a", "b" and "c".

A: a chemical method, which involves adding peroxide directly during the process of extrusion and the formation of the tubing. The peroxide decomposes, forming highly reactive free radicals, which can then abstract the hydrogen atoms from the polyethylene and create a chemical bond between the polymer chains at those points.

B: a two-step chemical method; firstly, with the addition of a SILANE compound, you get cross-linkable polyethylene, which has chemically active sites along the polymer chain. The actual cross-linking takes place during the extrusion of the tubing brought about by the addition of a catalyst and then hot water (80°C-95°C) or steam.

C: a physical method, which consists in blasting the tube with high energy rays in specialised bunker

Reticulated Polyethylene

Polyethylene(PE)is a thermoplastic material and as the temperature rises, the molecule chains which make it up (fig.1) slide over one another, irreversible deforming the plastic layers of the tube.

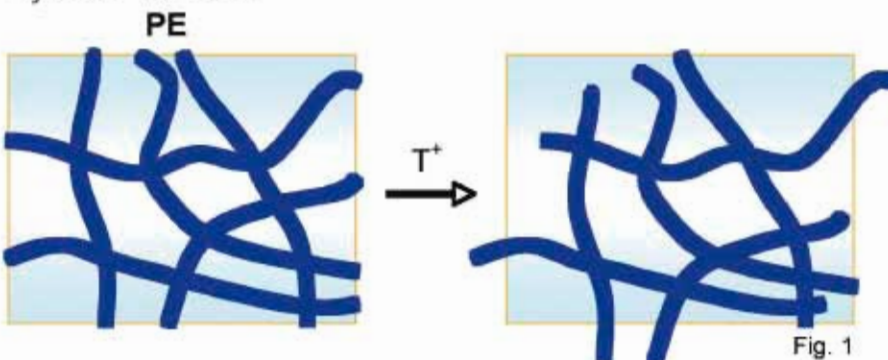

To guarantee the efficient use of the multi-layer tubing at temperatures of up to 95°C for a duration of up to 50 years, it's necessary to chemically modify the polyethylene, linking the majority of the macromolecules to one another (the degree of cross-linking is expressed in a percentage figure), through chemical links;

Such a process is given the name CROSS-LINKING of the Polyethylene and is indicated by the letter X (FIG.2), from which PE-X, which is used to highlight the chemical link established between the polymer chains. The cross-linking starts by breaking down the carbon-oxygen bonds at one or more points in the majority of the polymer chains, and progresses with the formation of the new transversal bonds between the chains, which restricts their movement and so the irreversible deformation of the tubing. It must be noted that the cross-linking of the polyethylene CANNOT be total (degree of cross-linking of 100%), as this would make the material fragile, which leads to the creation of a cross-link, which clearly cannot move, that is to say, does not allow irreversible deformation of the tubing. The cross-linked polyethylene with a percentage of between 60% and 80% boasts the properties of composite materials, where the cross-linked part confers strength and stability of form even at high temperatures, while the free chains guarantee flexibility

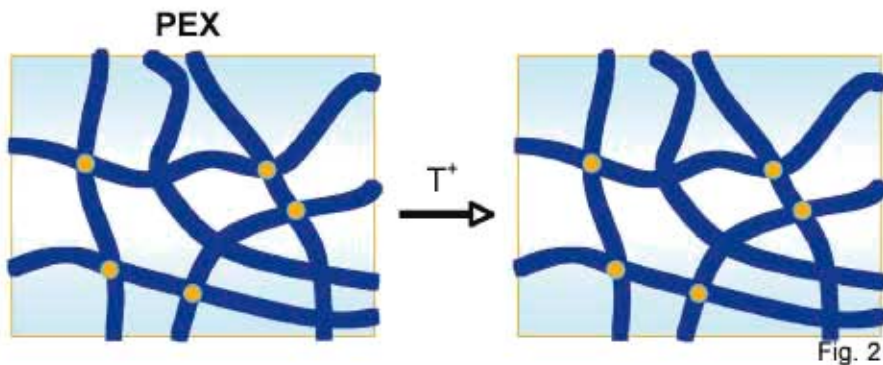

A cheaper – yet less efficient - alternative to improve the resistance of polyethylene to high temperatures is to polymerise ethylene and brass together, thus creating a copolymer in which the polymer chains are on average shorter, but have lateral ramifications on the chains themselves, which create an obstacle but do not hinder the movement when the temperature rises (FIG.3). The polyethylene which is manufactured this way is called PE-RT- “Raised Temperature” and NOT Cross-linked- and using it in the manufacturing of multi-layer tubing limits the highest possible temperature to lower values (70°C).

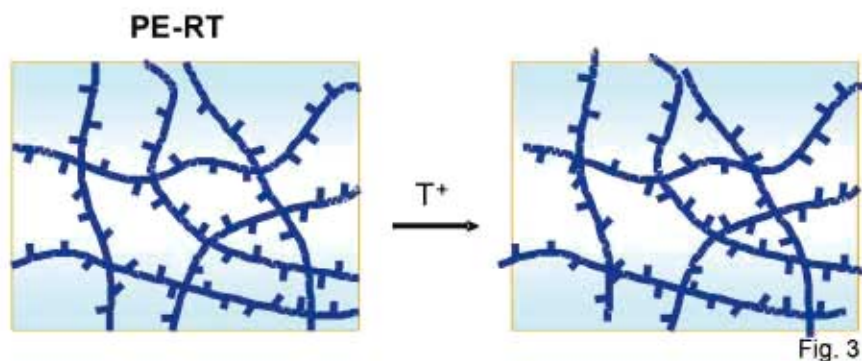

Everything described above is seen clearly and in detail in the typical regression curve regarding internal resistance vs. fracture time at different temperatures; The PE-RT curves highlight the fact that, already at temperatures superior to 60°C, you have a significant and unexpected fall in efficiency after a year of use, as clearly seen in the “knee” of the curve

Fig. 4

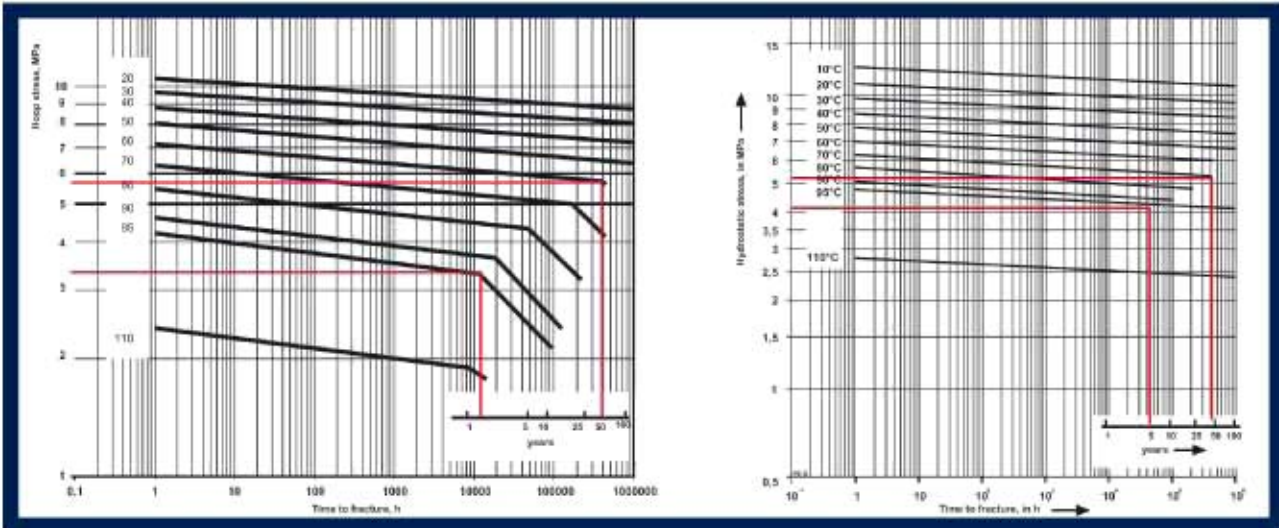

PE-RT regression

curve:
50 years 60°C
95°C : 1.2 years, 3.2 Mpa
ISO TC 138 SC2
N 961

PEX regression

curve:
50 years :70°C, 5.1MPa
95°C : 1.2 years, 4.1 Mpa
ISO15875-2

This decline of mechanical efficiency is, on the other hand, totally absent in the regression curve of PeX, where you have linear characteristics of the curve and the resistance values are decidedly higher. The polyethylene (PE) used to manufacture SESTA Multi-layer tubing is cross-linked (X) using the “b” PEXb method



Alternatives to PEX-AI-PEX

On the market there are other multilayered tubes that are not 100% PEX (Reticulated Polyethylene) in their plastic parts. PERT, PE-HD, or even ad hoc PEX-PE derived blends that are “alternative”, and evidently less functional in terms of pressure, temperature and durability (see fig. 4) regression lines .

The choice of non-reticulated plastic is exclusively one made for reasons of economy linked to the cost of the raw materials and to the simpler production process. Confirming what is above the new UNI TS 11344 Regulations for combustible gasses clearly establish the exclusive use of PEX for the internal layer.

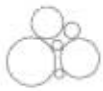

SESTA fittings

Since 2008 Sesta has included in its product range the Sesta press fittings in brass, with a proprietary design, and so has realised its own tube+fitting system.

From the very beginning of multilayer production, Sesta has always had both press and screw fittings from other commercial brands in its product list. The passage to the creation of its own proprietary Sesta System was compelled, first to guarantee quality and certainty of compatibility to the market and then to eliminate the passing of responsibility among the manufacturers of tubing and those of fittings. For Sesta System tubing the most used thicknesses on the market were adopted so that the use of the system is a choice of the end user and not an obligation. The tubing and the fittings are compatible with the greater part of the products on the market.



Sesta's investment has been oriented toward the range of brass press fittings, which, among the alternatives offered by technology, represent the best solution between innovation and tradition. This type exceeds the limits of the classical screw type of system and is preferable to bayonet type fittings and to all of those in plastic, which have not yet undergone sufficient experimentation in the field and do not provide substantial and significant advantages in terms of speed of installation. Assembly is realised by way of pressing the tube permanently onto the end fitting of the joint by way of a pressing machine fitted with proper crimper jaws. This permanently deforms the stainless steel bushing set to guarantee the press fitting of the tube also in the face of significant variations in pressure and temperature.



The seal is assured by the special anti shear profile of the end fitting and by the two o-rings on which the tube exercises a uniform pressure.

Among the numerous advantages that the press type fittings offer compared to the screw type, the following are to be noted:

- a) The locking of the tube on the fitting with a press type fitting is entrusted to mechanically standardised equipment, designed ad hoc and easy to use. The greater reliability compared to screw type fittings where the seal depends greatly on the ability of the installer is definite;
- b) The speed of the assembly and installation of the press fitting is one of its specific characteristics;
- c) The SESTA press fitting, being factory pre-assembled, reduces assembly errors, due to the possible loss of essential components, to a minimum;
- d) Finally, the press fitting is intrinsically single use: just one more guarantee of reliability. The sum of the above listed advantages enables the guarantee of the installation of SESTA press fittings also chased into walls or buried with no problem at all.



Press profiles



Among the different press profiles on the market, SESTA has designed its fittings for use with crimper pliers with a TH profile, surely the most widespread and the tested. The TH crimper pliers have a channelling that, in the pressing phase, hooks onto the plastic coloured bushing holder that acts as a guide and ensures the exact positioning of the same crimper pliers.



SESTA SRL



CHRYSSAFIDIS



the three sesta press profiles

During the design of the hose connection the possibility of using crimper pliers with a different profile was also examined.

The positioning of the o-rings in the SESTA fittings for tubes from 16 to 20 mm is compatible with two other profiles, which are also very common on the market: H and U. Many shear, seal and duration tests were performed, the results of which assure the complete compatibility of the SESTA press fitting with the type H and U profile crimper pliers.





technical characteristics

The tubing

The SESTA multilayer tube is produced both in rolls of various lengths and in bars. It meets the characteristics listed in the following table:

Tab. 7

OUTER DIAMETER	14 mm	16 mm	18 mm	20 mm	26 mm	32 mm	40 mm	50 mm	63 mm
INTERNAL DIAMETER	10 mm	12 mm	14 mm	16 mm	20 mm	26 mm	33 mm	42 mm	54 mm
ROLL LENGTH NUDE TUBE	100 m	100 m	100 m	100 m	50 m	50 m			
		250 m		400 m					
		500 m							
BAR LENGTH NUDE TUBE	4 m	4 m	4 m	4 m	4 m	4 m	4 m	4 m	4 m
COATED ROLL LENGTH	50 m	50 m	50 m	50 m	50 m	25 m			
		100 m			25 m				
COATING THICKNESS	6 mm	6 mm	6 mm	6 mm	6 mm	10 mm			
polyethylene closed-cell PE-LD	10 mm	10 mm	10 mm	10 mm	10 mm				
WEIGHT PER METER	90 g	110 g	130 g	145 g	260 g	340 g	528 g	766 g	1155 g
ALUMINUM THICKNESS	0,2 mm	0,2 mm	0,2 mm	0,25 mm	0,4 mm	0,45 mm	0,7 mm	0,9 mm	1,2 mm
WALL THICKNESS	2 mm	2 mm	2 mm	2 mm	3 mm	3 mm	3,5 mm	4 mm	4,5 mm
VOLUME OF WATER	0,078 l/m	0,113 l/m	0,154 l/m	0,200 l/m	0,314 l/m	0,531 l/m	0,803 l/m	1,32 l/m	2,042 l/m
INTERNAL ROUGHNESS	0,007 mm								
THERMAL CONDUCTIVITY	0,43 w/m°C								
COEFFICIENT OF THERMAL EXPANSION	0,026 mm/m°C								
CONTINUOUS USE TEMPERATURE	95°C								
MOMENTARY TEMPERATURE MAX	110°C								
MAXIMUM OPERATING PRESSURE	10bar								
DEGREE OF CROSSLINKING PEXB	>65%								
OXYGEN DIFFUSION	0,00 mg/lh								
RADIUS OF CURVATURE	fino a 5 volte il diametro								

Regression curves

The tube quality is evaluated by analysing the regression lines specific to that product. The regression curves in the figure below have been prepared, in the context of tests for product certification, by a specialist institute that operates in compliance with UNI IEC EN ISO/IEC17025, which DVGW commissioned to conduct a large series of tests on the Sesta system over a year.



Regression curves

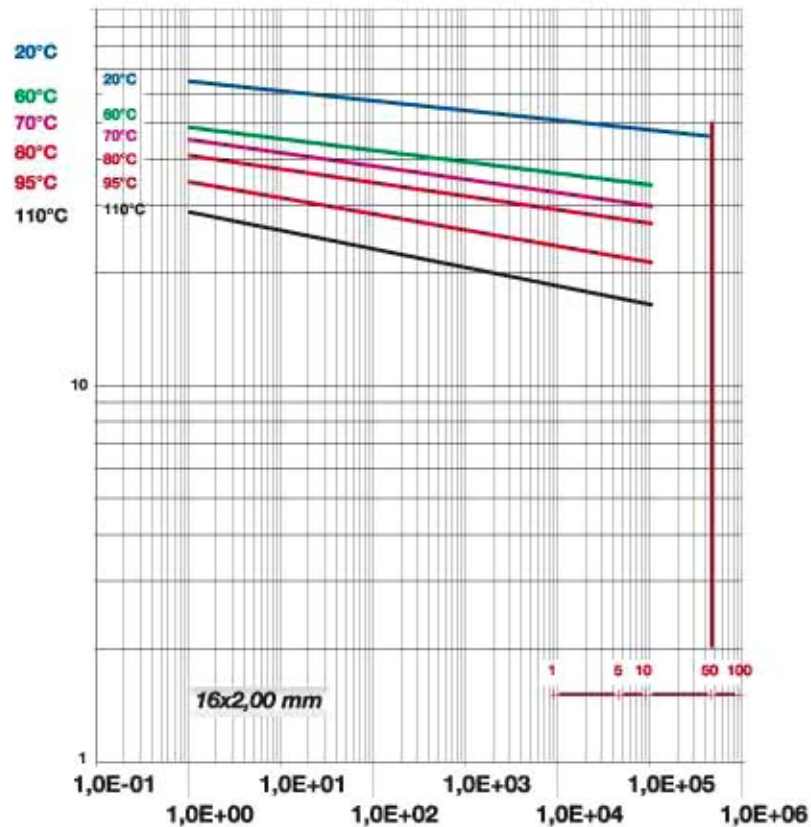
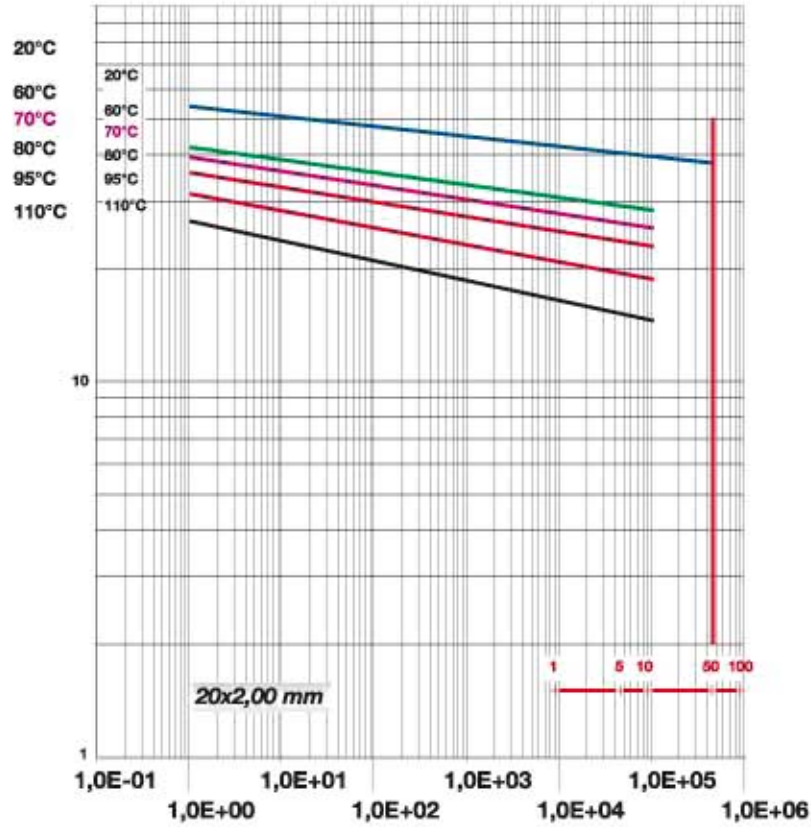

On the axis of abscissas (X) the times in hours and years are shown, on the ordinate axis (Y) the pressure that the tube can resist over time for different temperatures (20 °C, 60 °C, 70 °C, 80 °C, 95 °C, 110 °C) is shown.

The regression curves shown above for the aluminium DN 16 x 2 thickness 0.20 mm refer to a tube that, given its manufacturing characteristics, is subject to greater mechanical stress of the aluminium of the entire Sesta Line.

The values of S are shown below (indicated by the previous UNI 10954 regulations), which as is known is proportional to the stress of aluminium.

$S-(D-AI)/(2*AI)$

Tab. 8

DN	D	AI	S
14	14	0,2	35
16L	16	0,2	40
16	16	0,3	26
20L	20	0,25	40
20	20	0,35	28
26	26	0,4	32
32	32	0,45	35

As may be acknowledged, the regression curves indicate that the SESTA tubes satisfy the required characteristics in heating plants with high temperature radiators - naturally those that are less demanding for under floor systems - as well as the conditions anticipated for hot water supply. (See Table 2 of the "Reference Regulations" pag.4)

In other words, **the thermal, mechanical and hygienic characteristics of the SESTA SYSTEM are such that they cover all of the application classes defined by the UNI EN ISO 21003 Regulations.**

- Class 1 Hot water supply 60°C
- Class 2 Hot water supply 70°C
- Class 4 Under floor heating and low temperature radiators
- Class 5 High temperature radiators



The fittings

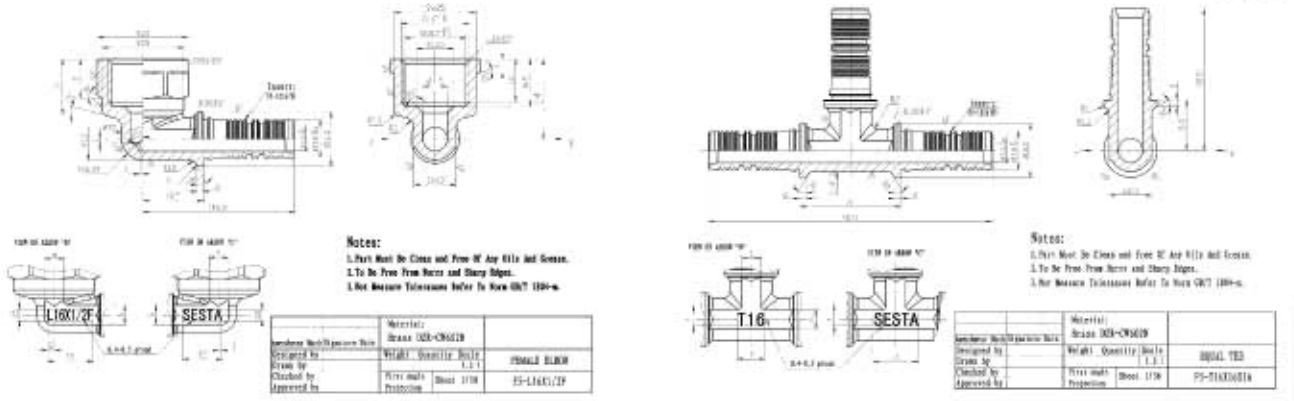

Fig. 5

The main technical specifications of the SESTA press fitting are:

- o Suitable for connection of multilayer tubes of the following dimensions:

external diameter (mm)	16	20	26	32
thickness (mm)	2	2	3	3

Tab. 9



- o CW602N anti-dezincification brass alloy body that resists corrosion even in contact with water that is extremely chemically aggressive, responding to the following chemical characteristics:

Tab.10



Analyse von Messingwerkstoffen

Pruf - Nr.: B340.3/7-W2
Auftrags-Nr.: 3137025

Zulassungsprüfungen nach DVGW 534, Fa. SESTA SRL

Ergebnisse der Wiederholung der Messinganalyse:



Element	max. Werte nach DIN 50930-6	Analysergebnisse		Bewertung
		D6		
Blei (Pb)	2,2%			+
Eisen (Fe)	0,3%			+
Nickel (Ni)	0,2%			+
Arsen (As)	0,1%			+
Aluminium (Al)	0,8%			+
Zinn (Sn)	0,3%			+
Mangan (Mn)	0,1%			+

+ Anforderung erfüllt

- o Coloured plastic bushing holder, not removable, which stops the contact between the aluminium of the tubing and the brass of the fitting and ensures, in this way, the absence of any possible electrochemical corrosion phenomena.
- o Coloured plastic bushing holder, acts as a guide for the crimper pliers.
- o Hot drop forging of the fitting body, compliant with the European EN 12165 Regulations, to insure the absence of porosity in the material.
- o Stainless steel bushing with three slots so as to visually verify the proper insertion of the tube on the fitting.
- o Certified EPDM, peroxide vulcanised o-ring, suitable for potable water contact.
- o EN 682 Certified o-ring for the transport of combustible gasses;
- o Hose end fitting with special anti-slip profile and o-rings placed in optimal position for the crimping with TH, H and U crimper pliers

Crimper pliers - Sesta three profile system dimensions

Press profile	DIAMETER FOR PIPE THICKNESS			
	16X2	20X2	26X2	32X3
TH	X	X	X	X
U	X	X		
H	X	X		

Tab. 11

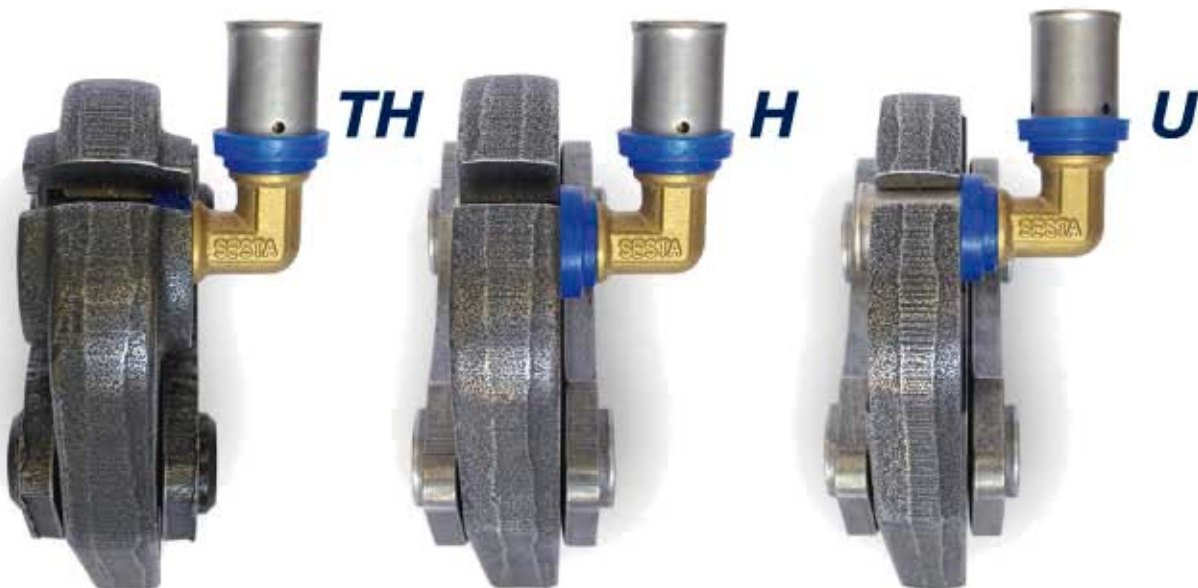

insulated tubes



Sesta also supplies PE-Xb multilayer tubing pre-insulated with closed cell polyethylene foam and a finish polyethylene film covering, in compliance with Law 10/91.

The characteristics of the clad tube make it ideal for water plant systems, heating and general air conditioning systems.

The technical specifications of the foam cladding are:

Sheath in PE-LD closed cell polyethylene foam

External PE-LD polyethylene finishing film

Contains no CFCs or HCFCs

"CLASS 1" Self Extinguishing

Thermal Conductance at 40 °C: 0.0397 W/m²K

Application Temperature -30 °C +95 °C

Water vapour diffusion resistance factor: 5.482μ

The external finish may be red, blue or white in colour and the thickness varies between 6 mm to 10 mm according to the diameters of the applications.



Application in Air Conditioning Systems

Air conditioning systems that use refrigerated water (usually around 7 °C and 1-2 bar) may use SESTA tubes and fittings because operational conditions are fully within those admitted by the System. A mixture, that besides water, contains ethylene Glycol as an antifreeze is also admitted.

For other refrigerant fluids it is necessary to verify that these are not aggressive towards PEX and brass. The SESTA System is not recommended for cryogenic fluid transport such as freon (HFC and HCFC) and/or ammonia.

For proper insulation the 10 mm cladding is recommended, which, compared to the lower thicknesses, besides giving better performance from a thermal point of view, better protects the tubes from the formation of condensation.

In regard to this, it should be mentioned that, in that the formation of condensation is not a phenomenon that is solely dependent upon the level of insulation but also on the temperature and humidity of the environment, it would be appropriate to verify the suitability of the cladding to the specific conditions in which the tube will be used, as indicated in the UNI EN ISO 12241 Regulations.

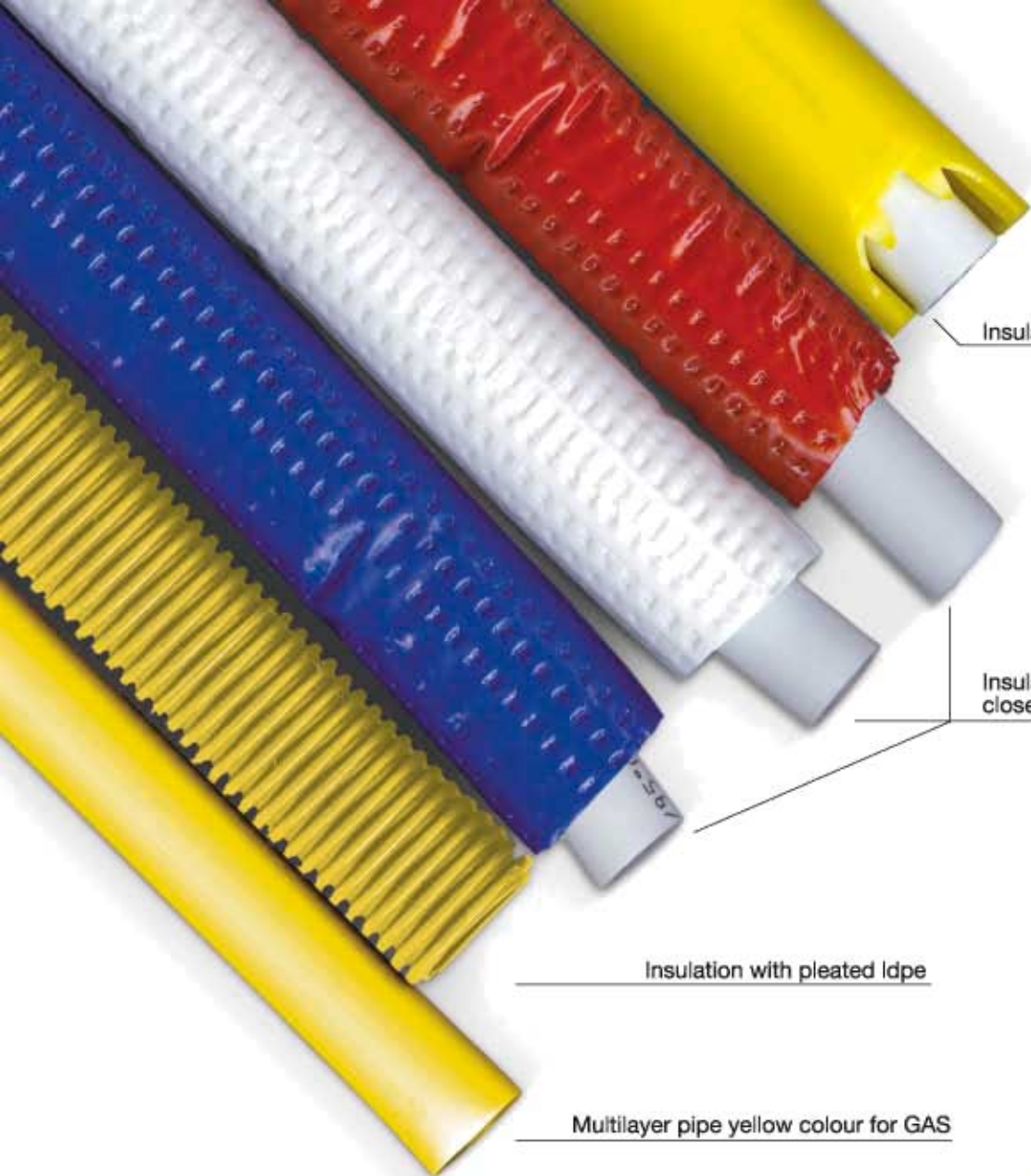

Insulation in ldpe with inner pipes

Insulation with ldpe sheet to closed cell estinguishing.

Insulation with pleated ldpe

Multilayer pipe yellow colour for GAS



CHRYSSAFIDIS

Section



Insulation in ldpe with inner pipes

Section

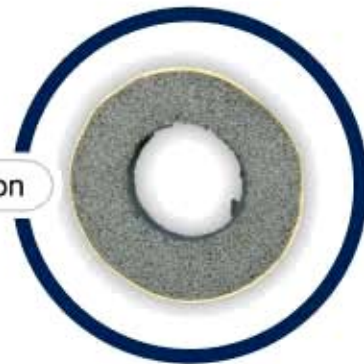

Insulation with ldpe sheet to closed cell estinguishing.



quality control



SESTA guarantees, by way of a rigorous system of "self inspection", the perfect correspondence of its products to the UNI EN ISO 21003 Regulations, certified by the (IIP) Italian Institute of Plastics No. 348 and by the W534 and W542 Technical Regulations certified by the German Authority DVGW No. DW-8231BU0247 (tubing) and No. DW-8501BU0248 (system).

Below some of the main inspections and tests are listed/



Raw Materials Inspections

All of the raw materials are supplied by first-rate companies. Suppliers and their respective products are registered in a specific "Supplier list". The use of new product requires a prior certification, which will be performed by way of a long (one month) and in depth series of tests made on a production lot that utilises the new materials. Only afterwards will tubes or fittings that use the new materials be put on the market and will be permitted to show the Certification **Authority mark**.

Compliance in order

Certification: respect for the mechanical technical specifications required according to the Sesta specifications

Melt flow index: level of fluidity

- With specific instrumentation the base polymer of the PE-X is heated and the viscosity, which must correspond to the given parameters, is measured.

Dry loss: Humidity level

- The humidity level of the base polymer of the PE-X is measured, an important factor for the quality of the reticulated polyethylene.

Camber of the aluminium: Aluminium tension cut

- The perfect square of the aluminium strips is verified as well as the corresponding lack of internal tensions, indispensable conditions so that in the passage under the welder the edges are properly positioned.

Degreasing: external surface cleaning of the aluminium

Roughness: of the external surface of the aluminium according to Sesta technical specifications these enable optimal adhesion of the adhesive.

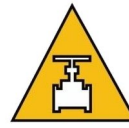
CHRYSSAFIDIS

Automatic on line checks and inspections

Diameter and thickness measurements:

- The production line has three ultrasound systems that constantly measure diameters and thicknesses of the different layers and, if a parameter nears the tolerance limit it calls this to the attention of the operators.

Aluminium weld control:

- An extremely sensitive system (EddyCheck) constantly checks the quality of the welds on the aluminium by way of an electrical induction current and measures its intensity in the area that is being welded as the process proceeds. Minimum imperfections of the welds are detected and notified, so that the line automatically cuts off and discards the section of tubing that has the defect.



Final on line checks and inspections

On all of the rolls

Check and inspection of the appearance and integrity of the external layer;

Check and inspection of the internal diameter with a calliper pass/fail;

Ball passage test:

- a ball with a diameter slightly smaller than that of the tube, is pushed through the roll of tubing by way of compressed air; this insures that there are no bulges in the internal layer or areas out of round.

On samples drawn from the production line each hour
Bending test to the minimum guaranteed diameter.

- To check and verify that there are no wrinkles or folds on the external surface of the tubing that would indicate poor adhesion of the layers.

Diameter and thickness checks:



Flare Test:

- The end of the sample is dilated with a calibrated plug and a check is made to insure that, over time, the internal layer does not tend to shrink and return to its original dimensions detaching itself from the aluminium.

Ungluing resistance

- On a small tract of tubing the aluminium layer is detached from the PEX layer and a verification is made to determine that the layers are well glued together and do not show areas in which the adhesive was not homogeneously distributed.



Laboratory Control

All of the samples drawn for inspection at the end of the production line are taken to the laboratory where they undergo the same tests again, but with appropriate measurement instrumentation. Namely:

Ungluing resistance

- This is performed with a dynamometric device that, as and when the test proceeds, records a graphic representation of the ungluing force.

The entire graph must have parameters above a minimum value.

Flare Test:

-The test is repeated with the insertion of a calibrated plug using a dynamometer that also measures the insertion force. Furthermore, the following additional tests are performed:

Measurement of the grade of reticulation:

- A PE-Xb reticulation grade greater than 65% must be found in a test inspection performed during each work shift.

Variation after thermal treatment and stretching

- A 10 cm sample of tubing is dried and ventilated in a locker at 120°C

- No ungluing or cracks between the layers must be verified

- The stretching must not be greater than 10% of the initial dimension.



Fittings inspections

Chemical analysis of the material

- The chemical composition must correspond to that indicated to insure potability requirements and resistance to dezincification.

Dimensional controls

- Correspondence to project drawings is constantly measured. (Fig. 5).



System Checks and Verifications

Resistance to temperature/pressure

- Samples of tubing, drawn for each day and for each lot are tested at 95 °C and 23 bar, respectively for a period of time of 165 hours or 1,000 hours (about a week or a month);
- These tests are to guarantee the resistance of the tubing at a pressure more than double that of maximum operational values.

Fitting Shear resistance

- A section of tubing between two joint fittings undergoes a set traction force measured by dynamometer and the fittings must not come apart.

Pressure cycles performed periodically on all of the diameters

- A standard circuit of SESTA tubes and fittings undergo 5,000 cycles of 0-10 bar pressure.
- The test simulates the resistance of the tubing and the seal of the joint to water hammering suffered over the service life of the system.

Thermal cycles performed periodically on all of the diameters

- This test is similar to the previous one, but here the 5,000 cycles alternate between a temperature of 20-95 °C.
- The test simulates the resistance of the tubing and the seal of the joint to sudden temperature changes suffered over the service life of the system.

Potability and Hygiene Requirements:

Compliance with the Ministerial Decree No. 174/2004 on Specific and Global Migration, is guaranteed both by the manufacturer of the plastic and by the semi-annual controls made on the finished product elaborated by external laboratories. This test is performed also as required by the DVGW Authority in compliance with W270 and with KTW at 20°C and 60°C (Pag. 5)



Additional Tests for Systems for Combustible Gas Transport



Gas constituent resistance test

- This test has the purpose of verifying that the materials that come into contact with the gas are not damaged by the substances contained in it. It is performed with use of suitable reagents for pre-established times, temperatures and pressures, in compliance with the UNI EN ISO 1167-1 – 2 Regulations (Appendix C).

Operational temperature resistance test

maximum service pressure of 0.5 bar and service temperature of -20°C to $+70^{\circ}\text{C}$.

- This test requires that the samples be repeatedly brought to 70°C and then to -20°C ; afterwards seal tests are performed.

Fire reaction test

- This is performed in compliance to the UNI EN 13501 Regulations.

O-ring

- These are specific for the conduction of gas and comply with the UNI EN 682 Regulations.



The certificate is framed in blue and contains the following text:

 E 

Attestano che
SESTA SRL
in
Jannone Vittoria
ha partecipato al convegno:

LA SICUREZZA NELL'UTILIZZO DEI GAS COMBUSTIBILI
ULTIME NOVITÀ ED AGGIORNAMENTI

San Donato Milanese (MI), 12 marzo 2010
Si rilascia il seguente attestato per gli usi consentiti dalla legge

CIG COMITATO ITALIANO GAS
IL SEGRETARIO



the certificates



Since it has begun operations, Sesta has put a corporate process quality management system into practice and has obtained ISO 9001-2000 certification, then updated to ISO 9001-2008.

Immediately after having obtained, from the Italian Plastics Institute, product compliance certification, at that time made up of only multilayer tubing, to the UNI 10954 Regulations, later implemented in compliance with the UNI EN ISO 21003 Regulations. With the introduction of the fittings the firm asked and obtained, from the German Institute DVGW, quality certification relative to the tubing, the fittings and the entire system of tubing and fittings.



Corporate Process Quality Certification



The SESTA corporate system in compliance with ISO 9001-2008 is certified by the IIP with the number IQNET IT 116468 and 739. Certification of corporate processes implicates that the Firm has put into place and respects rigorous management procedures regarding every aspect of the direction of the business, in particular those relative to product quality control (regulations, procedures, tests...)



Product quality certification

DVGW-Baumusterprüfung
DVGW type examination

Anwendungsbereich <i>field of application</i>	Produkte der... <i>products of...</i>
Zertifikatinhaber <i>owner of certificate</i>	Sesta srl Via Lancia,
Vertreiber <i>distributor</i>	Sesta srl Via Lancia,
Produktart <i>product category</i>	composite... <i>manufactur...</i>
Produktbezeichnung <i>product description</i>	multilayer p...
Modell <i>model</i>	SESTA
Prüfberichte <i>test reports</i>	mechanical KTW testing KTW testing hygienic test
Prüfgrundlagen <i>basis of type examination</i>	DVGW W 534 UBA KTW (DVGW W 270)
Ablaufdatum / AZ <i>date of expiry / file no.</i>	26.06.2014

21.07.2009 01 A-112
Date: Issued by, sheet, head of certification body

DVGW CERT GmbH - von der Deutschen Akkreditierungsstelle (DAk) in der TGA GmbH akkreditiert für die Konformitätsbewertung von Gas- und Wassererzeugern
DVGW CERT GmbH - accredited by Deutsche Akkreditierungsstelle (DAk) in the TGA GmbH for conformity assessment of gas and water supply

DVGW-Baumusterprüfung
DVGW type examination

Anwendungsbereich <i>field of application</i>	Produkte d... <i>products of...</i>
Zertifikatinhaber <i>owner of certificate</i>	Sesta srl Via Lancia
Vertreiber <i>distributor</i>	Sesta srl Via Lancia
Produktart <i>product category</i>	installation (8501)
Produktbezeichnung <i>product description</i>	drinking wa... PE-Xb/Al/P
Modell <i>model</i>	SESTA
Prüfberichte <i>test reports</i>	mechanical
Prüfgrundlagen <i>basis of type examination</i>	DVGW W 534 BGA KTW DVGW W 270
Ablaufdatum / AZ <i>date of expiry / file no.</i>	26.06.2014

21.07.2009 01 A-112
Date: Issued by, sheet, head of certification body

DVGW CERT GmbH - von der Deutschen Akkreditierungsstelle (DAk) in der TGA GmbH akkreditiert für die Konformitätsbewertung von Gas- und Wassererzeugern
DVGW CERT GmbH - accredited by Deutsche Akkreditierungsstelle (DAk) in the TGA GmbH for conformity assessment of gas and water supply

CERTIFICATO DI CONFORMITÀ
Certificate of conformity

n° 108 / 2010 — Rev. 0

Prodotti <i>Products</i>	Tubi multistrato metallo-plastici per sistemi di tubazioni per acqua calda e fredda Metal-Plastic multilayer pipes for piping system for hot and cold water
Gamma di prodotti <i>Range of products</i>	vedere allegato / see annex
Norma <i>Standard</i>	UNI EN ISO 21003 - 2 : 2009
Nome commerciale <i>Trade name</i>	SESTA MULTISTRATO PEXb-Al-PEXb
Produttore <i>Manufacturer</i>	SESTA SRL
Sede legale <i>Head office</i>	CONTRADA OLIVOLA Z.I. - VIA LANCIA SNC — 82100 BENEVENTO (BN)
Sito produttivo <i>Production site</i>	CONTRADA OLIVOLA Z.I. - VIA LANCIA SNC — 82100 BENEVENTO (BN)

Istituto Italiano dei Plastici S.r.l. (I.I.P. S.r.l.) certifica che i prodotti sopra elencati sono conformi alla norma indicata ed ai requisiti di I.I.P. S.r.l. specificati nel Regolamento generale e nelle Regole particolari applicabili e valutati secondo le prescrizioni del documento Sincert RT-06.
Il produttore, sottoposto a sorveglianza continua da parte di I.I.P. S.r.l., è autorizzato ad apporre sui prodotti certificati il marchio IIP-UNI con numero distintivo 348.
Il presente certificato di conformità è valido (salvo modifica, sospensione o revoca) fino al 31/12/2010.
Istituto Italiano dei Plastici S.r.l. (I.I.P. S.r.l.) certifies that the above listed products are in conformity with the indicated standard and the requirements of I.I.P. S.r.l. specified in the general Rules and in the applicable particular Rules and evaluated against Sincert document RT-06.
The manufacturer, which is subjected to continuous surveillance by I.I.P. S.r.l., is entitled to put on the certified products the IIP-UNI conformity Mark with the distinctive number 348.
This certificate of conformity is valid (without modification, suspension or withdrawal) until 31/12/2010.

Dalmine, 26/02/2010

ISTITUTO ITALIANO DEI PLASTICI S.r.l.
via Pasubio 5 - 24044 Dalmine (BG) - www.iip.it - info@iip.it
Il Presidente
(dr. Graziano Violotto)

SINCERT
SISTEMA ITALIANO
PER LA CERTIFICAZIONE
DEI PRODOTTI
E DEI SERVIZI

n. 348

This certification insures that the production and control processes for all the Sesta tubing are compliant with the UNI EN ISO 21003 Regulations.

n. DW 8231 BU 0247 DVGW

This certification insures that the production and control processes for all the Sesta tubing are compliant with the W534-UBA KTW-DVGW W270 Regulations.

n. DW 8501 BU 0248 DVGW

This certification insures that the production and control processes for the entire SESTA SYSTEM made up of the tubing and fittings are compliant with the W534-BGA KTW-DVGW W270 Regulations.

Other certificates

The Sesta quality certification of its tubing has been accepted by the following foreign certification authorities:

Aspects of Certification

Being certified implicates undergoing a “re-examination” each year in which the certification authorities verify the updating and the adequacy of the procedures, ascertain that all of the tests required by the self-verification system have been performed and registered, that those of the last lots are being undertaken, that the measurement instruments have undergone all of the required verifications for calibration and conservation of the validating samples for each lot. In addition, they draw some samples from the warehouse on which the same tests are repeated in their own laboratories.

Over the course of the year, then, the Certification Institute performs surprise check inspections in the firm and carries out tests on samples purchased directly from resellers. It is necessary to pay attention to not confuse the **certification**, provided by approved third party Institutes, with **self certifications** and with **episodic laboratory tests**.

The self-certifications are issued autonomously by the individual manufacturers without any controls by third party authorities and consist in the mere declaration that the production is compliant with the reference regulations in effect.

Episodic tests, issued by specialised laboratories, performed one off on individual samples, do not guarantee the repetition of the data and are not part of a quality management system.



**CHRYSSAFIDIS**

installation information

Appendage B of the UNI/TS 11343:2009

APPENDICE B DISPOSIZIONI PRATICHE PER L'INSTALLAZIONE DEI RACCORDI NEI SISTEMI DI TUBAZIONI MULTISTRATO METALLO-PLASTICHE (informativa)

B.1 Precauzioni generali

Le istruzioni per il trasporto, stoccaggio e la posa in opera del sistema, riportate sul libretto d'istruzioni, devono sempre essere rese disponibili dal produttore e rispettate dall'installatore.

L'installatore deve sempre verificare l'integrità del raccordo prima dell'installazione.

È vietato:

- l'utilizzo di raccordi visibilmente danneggiati o comunque non ben conservati;
- l'utilizzo di attrezzi e/o ganasce/dime diverse da quelle indicate dal produttore del sistema nel libretto di istruzioni ed avvertenze;
- l'utilizzo di tubi diversi da quelli indicati dal produttore del sistema nel libretto di istruzioni ed avvertenze;
- manomettere o sostituire l'eventuale guarnizione di tenuta.

Nell'operazione di trasporto è opportuno appoggiare i tubi su superfici lisce ed evitare sporgenze non necessarie. I tubi consegnati in cantiere (normalmente approntati in rotoli o in verghe) devono essere stoccati in luoghi al riparo dalla luce solare e dal calore allo scopo di non causare alcun danno alla superficie del tubo. È buona pratica mantenere i tubi nell'imballaggio originale che contribuisce alla perfetta conservazione al fine di proteggere il materiale dai raggi UV per irraggiamento solare ed evitare il contatto con corpi taglienti od abrasivi.

B.2 Pulizia delle ganasce e dime di pressatura

La superficie delle ganasce/dime di pressatura, nella zona dove esse entrano in contatto con il raccordo a pressare, deve essere mantenuta pulita e priva di scorie metalliche, oltre che lubrificata.

Tale pulizia deve essere periodicamente effettuata dall'installatore con attrezzi idonei indicati dal produttore.

B.3 Manutenzione e revisione dell'attrezzo di pressatura e delle ganasce

Al fine di garantire l'efficienza nel tempo dell'attrezzo di pressatura e delle ganasce, l'installatore deve provvedere a far eseguire la manutenzione e la revisione periodica dell'attrezzatura, secondo le modalità previste dal produttore.

B.4 Estremità del tubo da inserire nel raccordo

Al fine di realizzare una corretta giunzione con i raccordi, l'installatore deve controllare che l'estremità del tubo non presenti residui, bave taglienti e tagli non perpendicolari, a difesa dell'integrità della guarnizione di tenuta (se esistente).

Appendage A of the UNI/TS 11343:2009

APPENDICE
(informativa)

A DIMENSIONAMENTO DELLE TUBAZIONI MULTISTRATO METALLO-PLASTICHE VALIDE PER GAS NATURALE E GAS DI PETROLIO LIQUEFATTO (GPL)

Il dimensionamento di un impianto interno del gas combustibile può avvenire nel modo seguente:

- in base alla portata termica nominale, riportata sulla targa degli apparecchi utilizzatori, si determina la massima portata oraria in volume richiesta per ogni tratto di impianto;
- si misura lo sviluppo geometrico delle tubazioni e si sommano ad esso le lunghezze equivalenti per i pezzi speciali presenti ottenendo le lunghezze virtuali (le lunghezze equivalenti dei pezzi speciali sono riportate nei prospetti forniti dal produttore);
- in base alla densità relativa del gas combustibile si sceglie la portata corrispondente (tali portate sono riportate nei prospetti forniti dal produttore) e si procede al dimensionamento tratto per tratto, adottando per lunghezze virtuali e portate i valori più vicini per eccesso dati dai prospetti e da questi ricavando il diametro da adottare.

La formula utilizzata per il dimensionamento degli impianti interni è la seguente²⁾:

$$P_A - P_B = \frac{\lambda \times v^2 \times \gamma \times L}{200 \times D_i}$$

dove:

P_A è la pressione relativa in un punto A (in mbar);

P_B è la pressione relativa in un punto B (in mbar);

λ è il coefficiente di attrito = $\lambda_0 + b/D_i$

$$\lambda_0 = 0,0072 + \frac{0,612}{Re^{0,35}},$$

$$b = 2,9 \times 10^{-5} \times Re^{0,109},$$

$$Re = \text{numero di Reynolds} = 354 \times \frac{Q}{D_i \times \nu} \times 10^{-6}$$

Q = portata di gas (in m³/h, a 15 °C e 101,325 kPa),

ν = viscosità cinematica (in m²/s);

v è la velocità del gas (in m/s) = $Q / (2\,827 \times D_i^2)$;

γ è la massa volumica del gas (kg/m³, a 15 °C e 101,325 kPa);

L è la lunghezza virtuale della tubazione (in metri);

D_i è il diametro interno della tubazione (in metri).

installation information



Fitting Installation Instructions to PRESS



1. Cut the tubing perpendicularly to its axis with a multilayer tube cutter.



2. Trim the cut tube with the specific tool.



3. Calibrate the tube inserting the specific calibrator pin and rotating it inside of the tube (if on the calibrator pin there has been attached the specific bit, operations 2 and 3 are performed together).



4. Insert the fitting and make sure that, by way of the specific holes in the bushing, that the tube is pushed to its stop limit on the bushing holder in coloured plastic. In the event that the insertion of the fitting meets with excessive resistance, operations 2 and 3 are to be repeated.



5. Position the crimper pliers with the TH profile so that the specific slot on the jaws corresponds to the bushing holder in coloured plastic and proceed to the crimping of the tube grip bushing (for the H and U profiles position the crimper pliers in contact with the bushing holder in coloured plastic). Proper positioning of the tube in the fitting and of the same fitting in the crimper pliers are indispensable for the normal operation of the system. For proper operation of the crimper press consult the instruction manual of the same.



6. Once the crimping has been performed, open the jaws and remove the pliers.

Istruzioni di montaggio dei raccordi a STRINGERE



1. Cut the tubing perpendicularly to its axis with a multilayer tube cutter.



2. Trim the cut tube with the specific tool.



3. Calibrate the tube inserting the specific calibrator pin and rotating it inside of the tube (if on the calibrator pin there has been attached the specific bit, operations 2 and 3 are performed together).



4. Slide in the tube, in this order, the nut and the cut ferrule



5. Insert the tube holder fitting in the tube paying attention that this goes all the way to its stop point on the gasket fitted to the fitting.



6. Screw down the nut by hand as far as possible and then tighten with a spanner.



Bending

During the bending process it is imperative that one absolutely avoid the creation of deformations on the internal side of the bend, the heating of the tube or the damage of the external PE-X cladding of the tube.

The tube may be bent to a minimum radius equal to 5 times the diameter, if performed by hand, and up to 3.5 times the diameter with the tube bender. In the following tables the minimum bend radii are found:

tube diameter	14	16	18	20	26	32
radius of the bend by hand	70	80	90	100	130	160
raggio di curvatura by tube bender	49	56	63	70	91	112



Thermal dilation

Even though the multilayer tubing has a fairly low thermal dilation coefficient, comparable to that of metals, 0.026 mm/(m °C), it is still necessary to take into consideration any stretching due to temperature variations, above all when fairly long tracts are being laid.

In the following table, the thermal dilations in mm are shown for the variation of the lengths in m and the temperatures in °C.

Length of the tube	temperature variation						
	10	20	30	40	50	60	70
1	0,3	0,5	0,8	1,0	1,3	1,6	1,8
2	0,5	1,0	1,6	2,1	2,6	3,1	3,6
3	0,8	1,6	2,3	3,1	3,9	4,7	5,5
4	1,0	2,1	3,1	4,2	5,2	6,2	7,3
5	1,3	2,6	3,9	5,2	6,5	7,8	9,1
6	1,6	3,1	4,7	6,2	7,8	9,4	10,9
7	1,8	3,6	5,5	7,3	9,1	10,9	12,7
8	2,1	4,2	6,2	8,3	10,4	12,5	14,6
9	2,3	4,7	7,0	9,4	11,7	14,0	16,4
10	2,6	5,2	7,8	10,4	13,0	15,6	18,2

During installation on site, these length variations need to be considered. In fitted or embedded tubing installations these stretching/shrinking actions may be absorbed by the foam that is used for thermal insulation. With tubing in the air, it is necessary to set up suitable fixed and sliding supports so that dilations in straight-line tracts are not impeded. For long tracts it could be useful to anticipate omega shaped expansion joints.

Resistance to UV rays

Store the Sesta multilayer tubing protected from direct sunlight and UV radiation. The insulation cladding is in itself a protection.

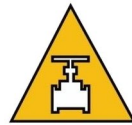

Load loss

In the graph below, for each tube in the SESTA list it is possible to detect the load loss in mbar/m, in function of the flow rate or of the speed of the water.



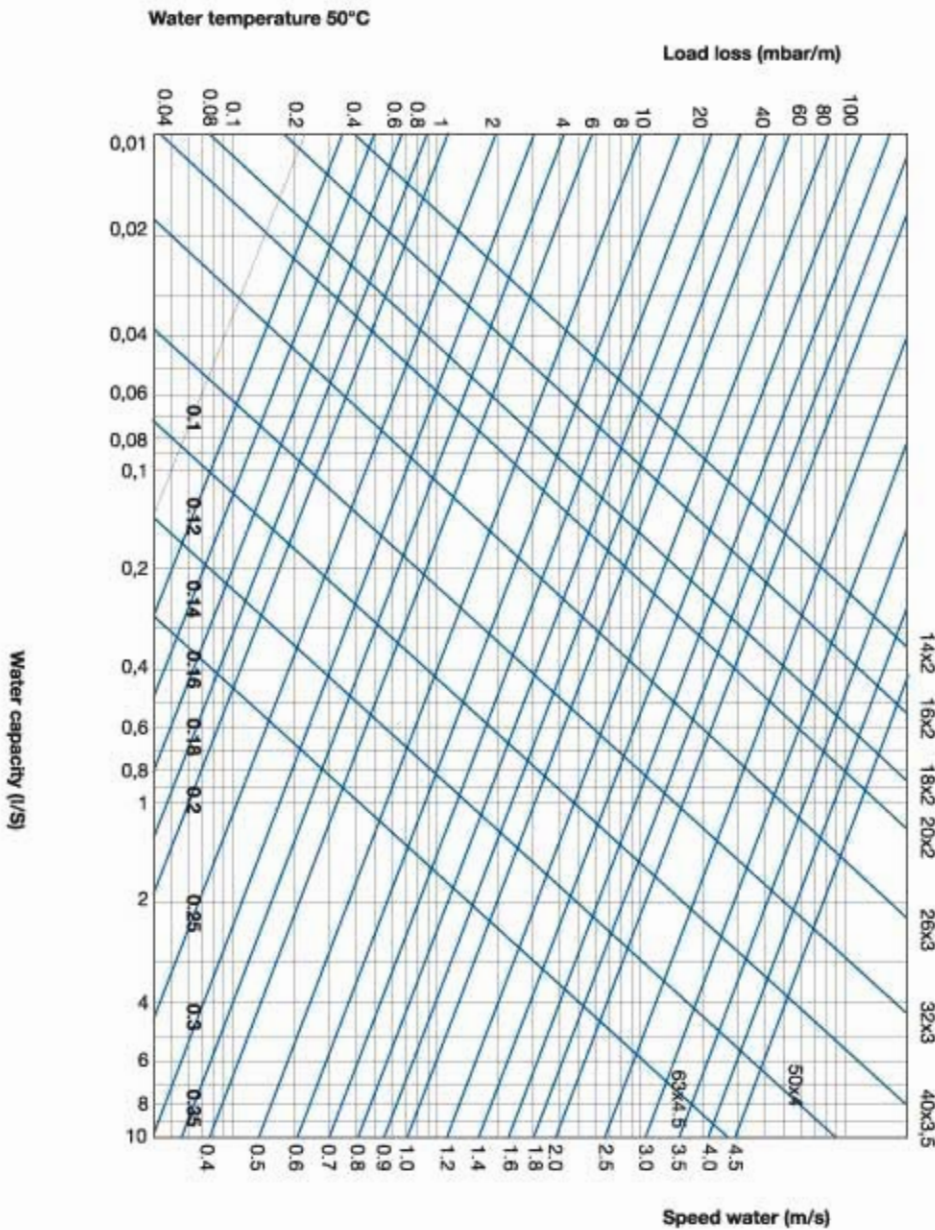



For the bends and the fittings refer to the following table in which the load losses are reported in "metres of equivalent tubing".



In the graph below, for each tube in the SESTA list it is possible to detect the load loss in mbar/m, in function of the flow rate or of the speed of the water.



For the bends and the fittings refer to the following table in which the load losses are reported in "metres of equivalent tubing".

DIAMETER	CURVED TUBE	STRAIGHT	ELBOW	TEE	TEE	TEE
						
14x2	0,75	1,15	1,80	1,50	1,75	1,90
16x2	0,63	0,80	1,40	1,00	1,53	1,50
18x2	0,60	0,75	1,30	0,90	1,50	1,35
20x2	0,54	0,65	1,10	0,73	1,44	1,24
26x3	0,50	0,25	1,05	0,62	1,40	1,20
32x3	0,50	0,95	0,58	1,30	1,10	1,10
40x3,5	0,45	0,35	1,15	0,55	1,20	1,25
50x4	0,48	0,45	1,15	0,65	1,20	1,30
63x4,5	0,50	0,50	1,20	0,70	1,10	1,25

guaranties, responsibilities, insurance

Sesta srl is responsible for manufacturing faults recognised after technical verifications as indicated in the DPR 24\ 5 \88 no. 224 for 10 years from the date of production.

The proper operation of the Sesta system is guaranteed with exclusion of the parts from other companies and in any case does not guarantee the faulty or unsuitable use of its products.

Indemnification or compensation for damages will not be recognised in the case that Sesta is not given the possibility of performing a technical verification.

In case of loss the following minimum documentation must be delivered to Sesta:

- No. Transport Documents
- Client order reference no.
- Material
- Quantity
- Type of defect found
- Method of detection
- Samples, and photographic documentation
- Cost estimate for restoration

Working in the ISO 9001/2008 certified system Sesta is able to track its products by retracing back through the entire production and inspection process all the way to the raw materials.

Sesta has, in addition, stipulated an insurance policy for "Civil Responsibility" and "Product Recall" covering any possible losses, of course as long as the reporting procedures, synthetically referenced above, have been respected.